

A-A

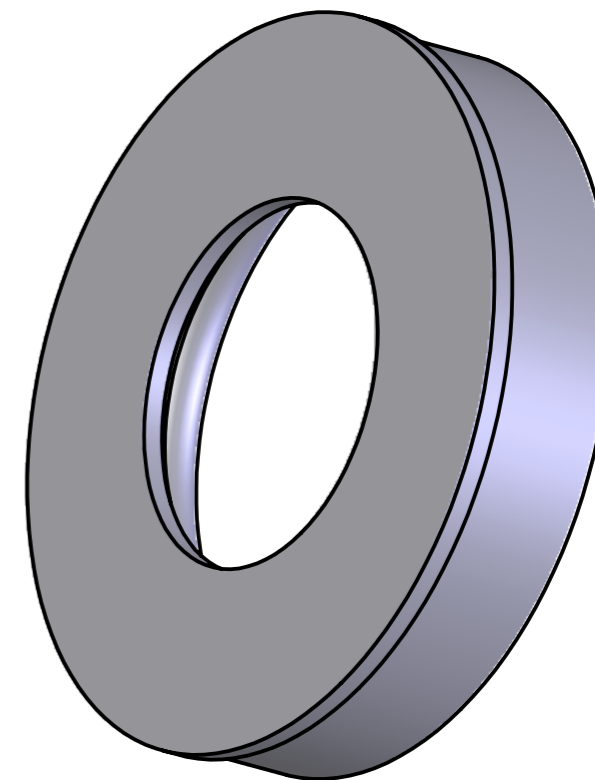
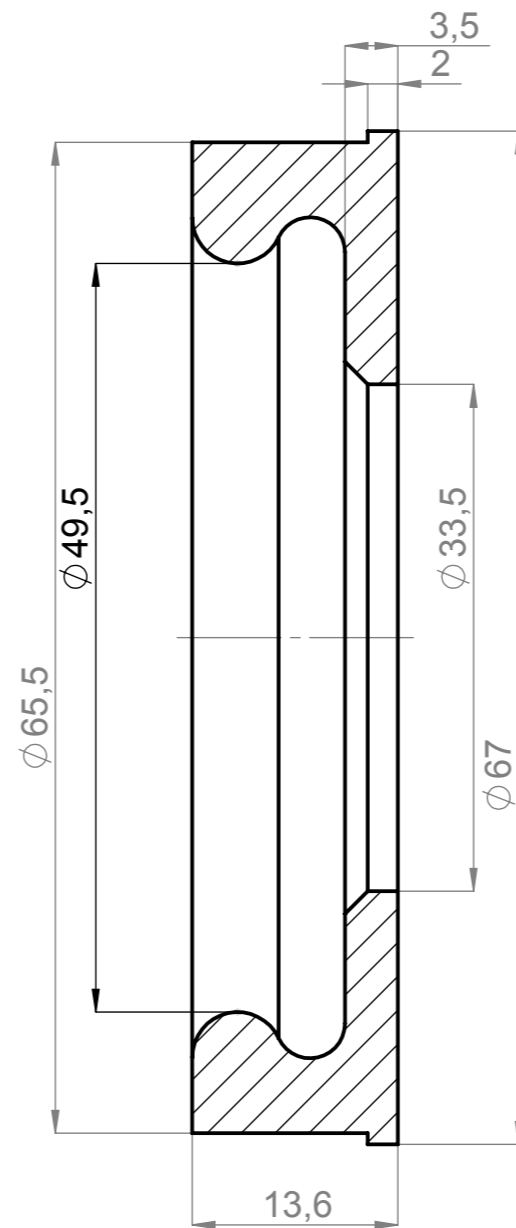

	Imię i nazwisko	Podpis	Data	Nazwa części	Objętość	Materiał
Konstruował:	P.D.			D9	21094 [mm <sup>3</sup> ]	NBR
Sprawdził:						
Zatwierdził:						
Skala: 2:1				P.P.H.U. Singiel Produkcja wyrobów z gumy	Cecha detalu Uszczelka	