

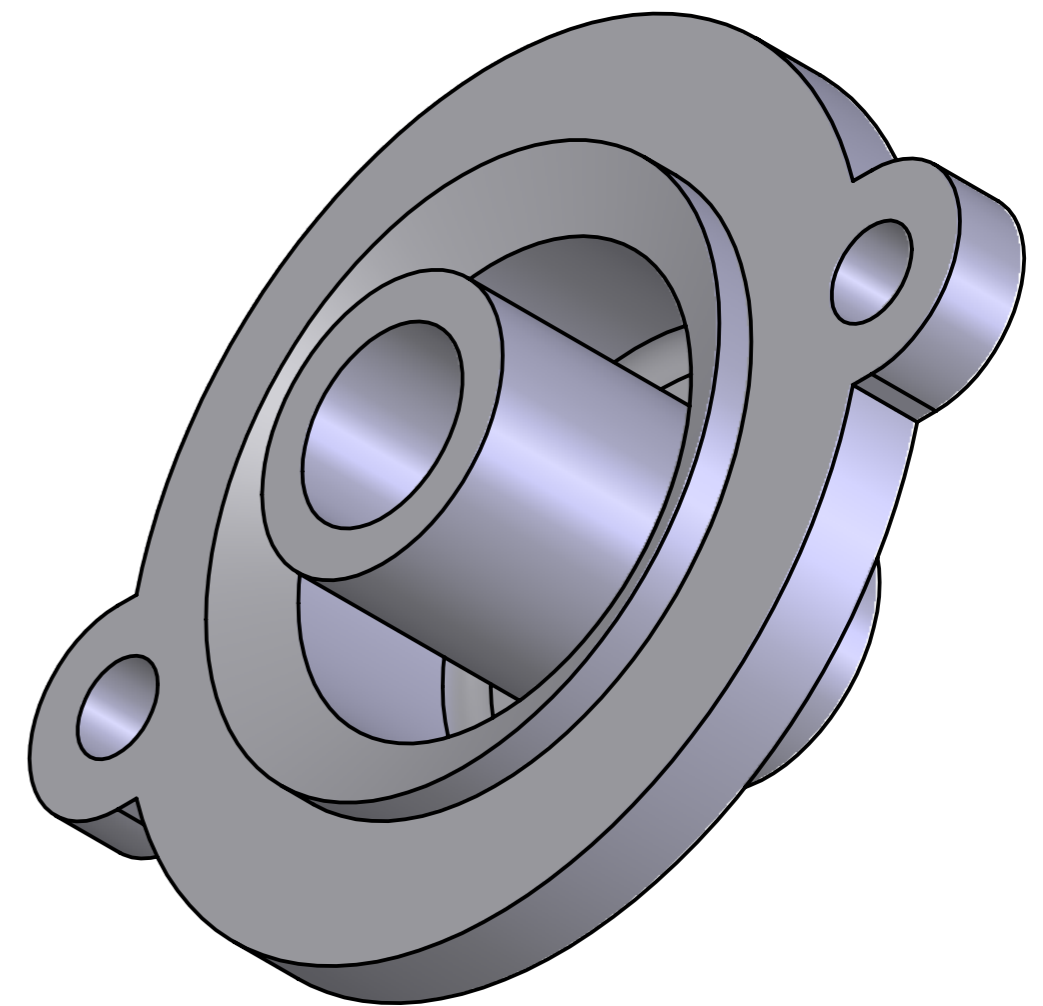

A-A

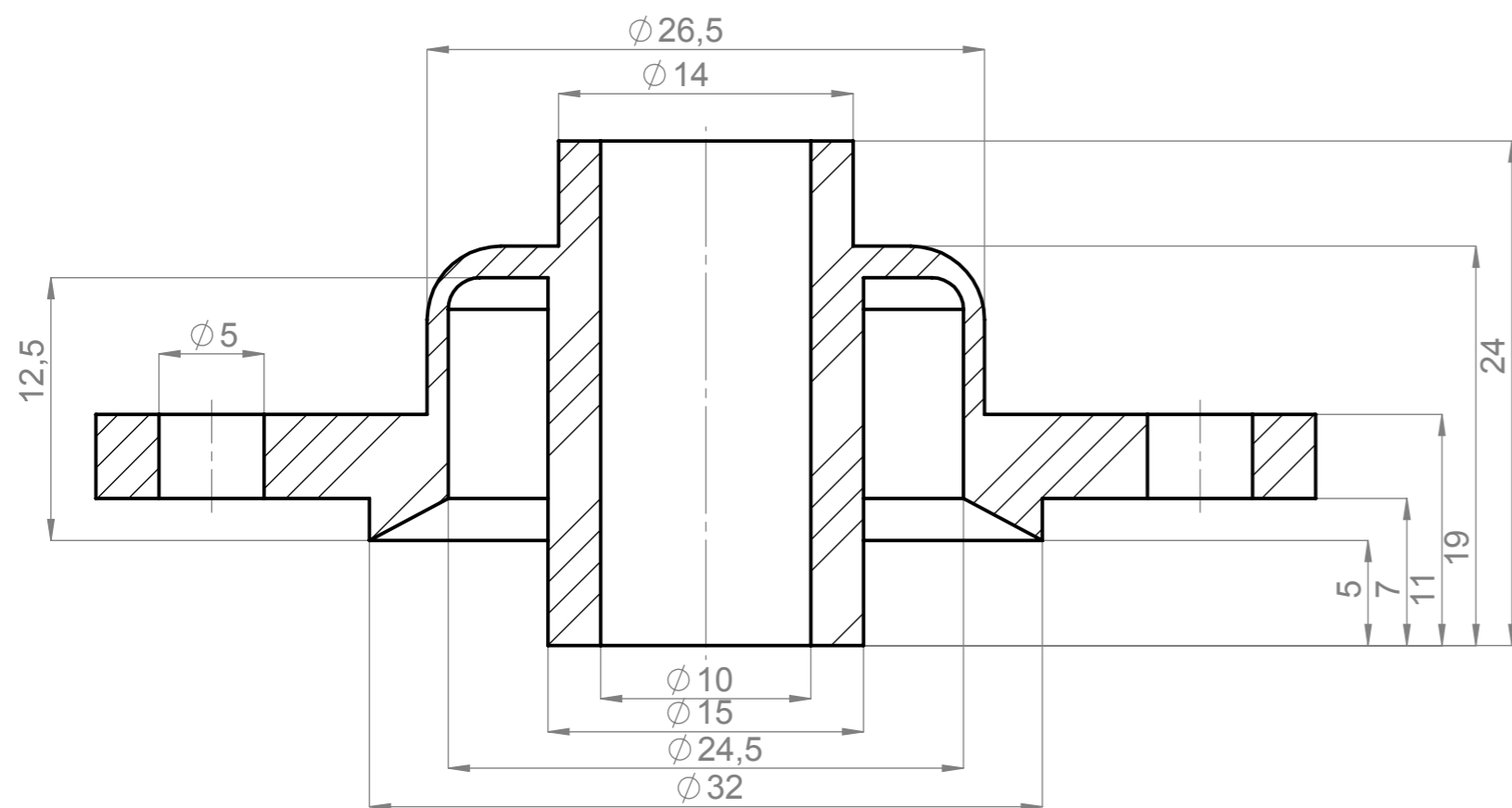

	Imię i nazwisko	Podpis	Data	Nazwa części	Objętość	Materiał
Konstruował:	P.D.			D86	8551 [mm ³]	NBR
Sprawdził:						
Zatwierdził:						
Skala: 3:1			P.P.H.U. Singiel Produkcja wyrobów z gumy		Cecha detalu Uszczelka	