

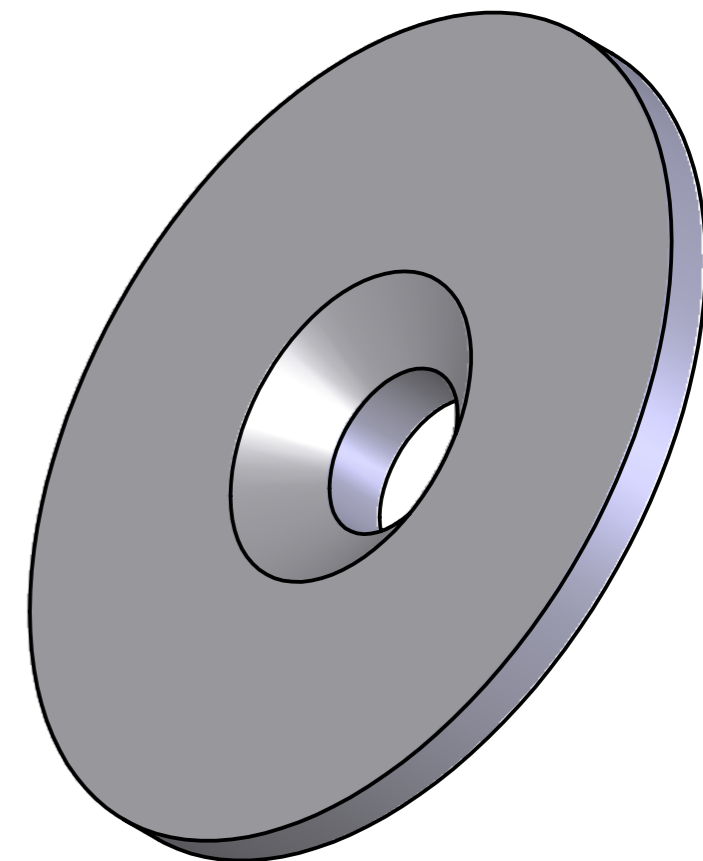

A-A

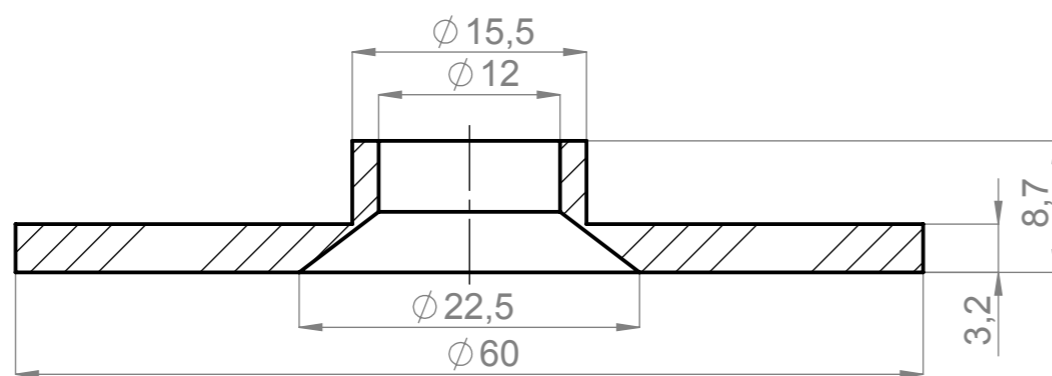

	Imię i nazwisko	Podpis	Data	Nazwa części	Objętość	Materiał
Konstruował:	P.D.			D65	8590 [mm ³]	NBR
Sprawdził:						
Zatwierdził:						
Skala: 2:1				P.P.H.U. Singiel Produkcja wyrobów z gumy	Cecha detalu Tuleja	