

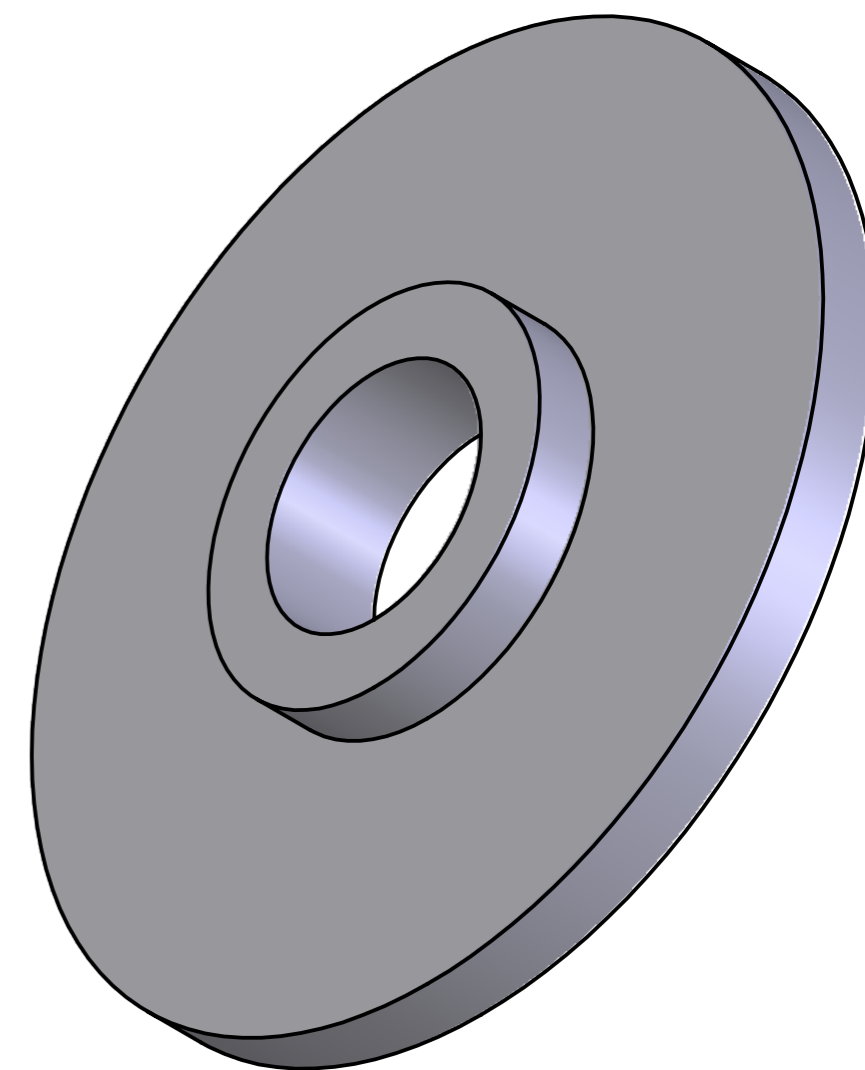

A-A

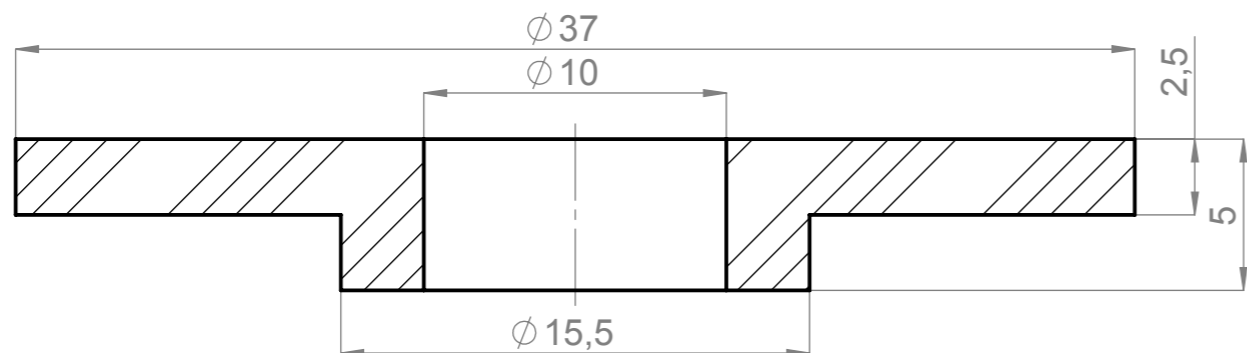

	Imię i nazwisko	Podpis	Data	Nazwa części	Objętość	Materiał
Konstruował:	P.D.			D229	2767 [mm <sup>3</sup> ]	NBR
Sprawdził:						
Zatwierdził:						
Skala: 4:1	 P.P.H.U. Singiel Produkcja wyrobów z gumy			Cecha detalu Uszczelka		