

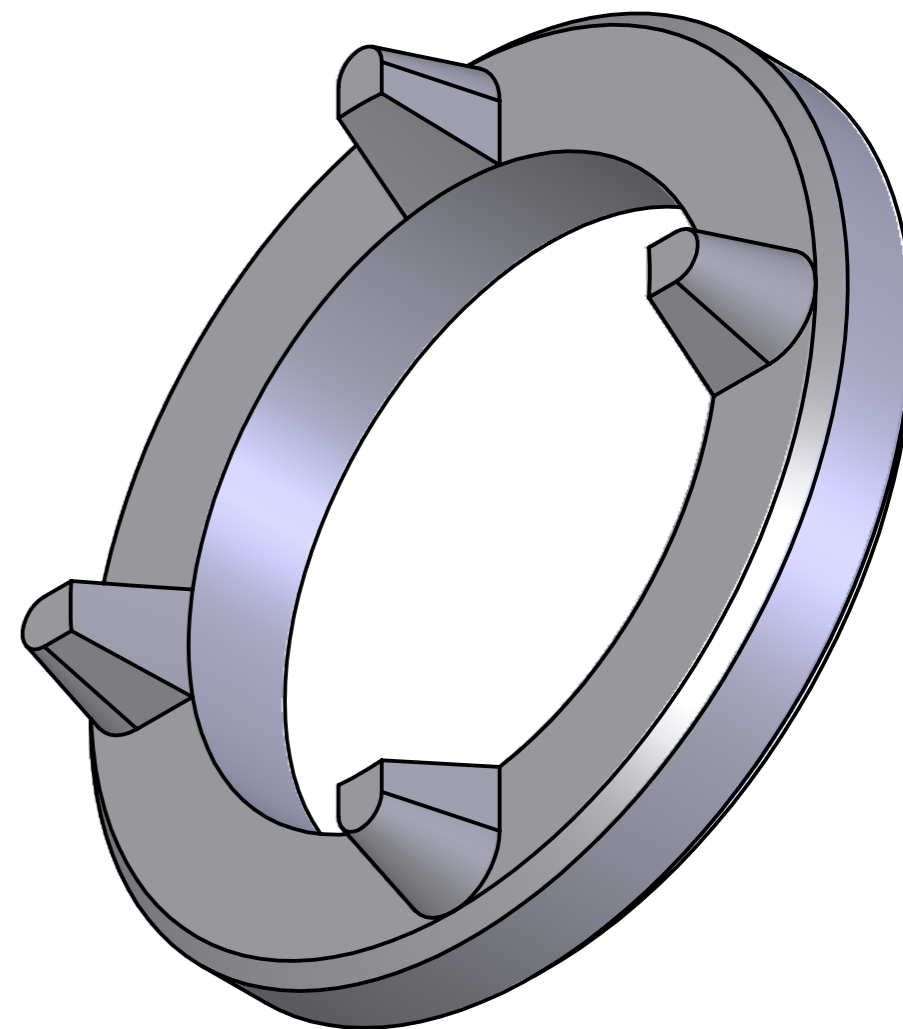

A-A

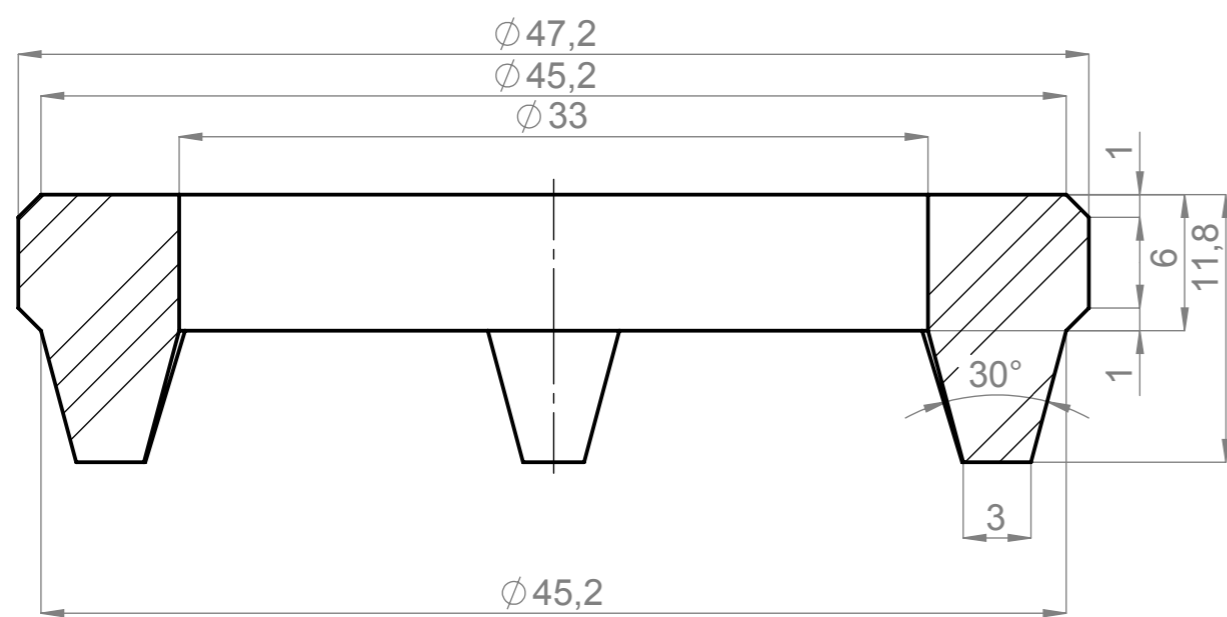

	Imię i nazwisko	Podpis	Data	Nazwa części	Objętość	Materiał
Konstruował:	P.D.			D214	5645 [mm <sup>3</sup> ]	NBR
Sprawdził:						
Zatwierdził:						
Skala: 3:1				Cecha detalu Uszczelka		