

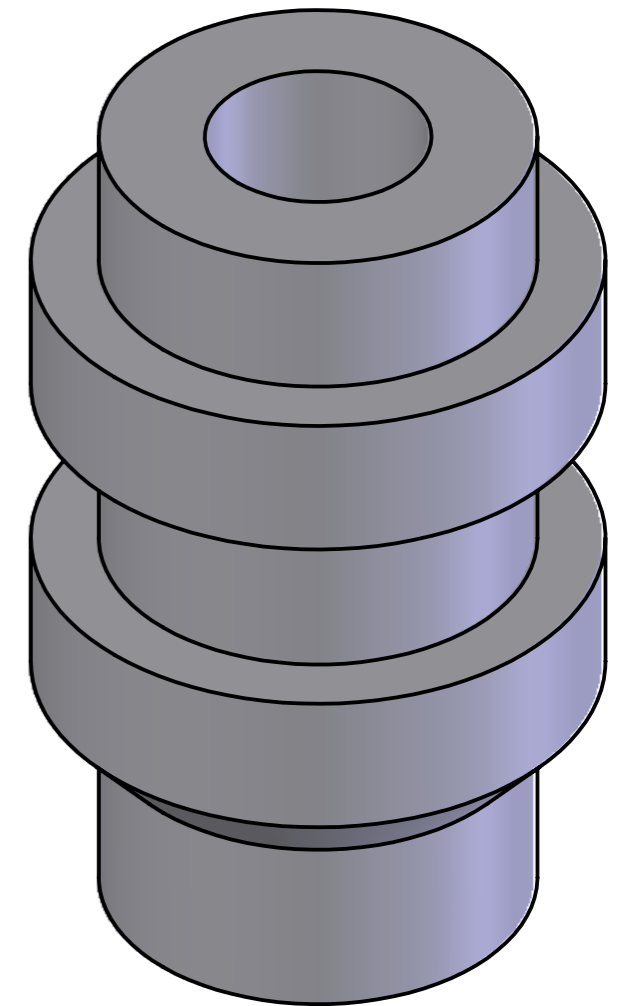

A-A

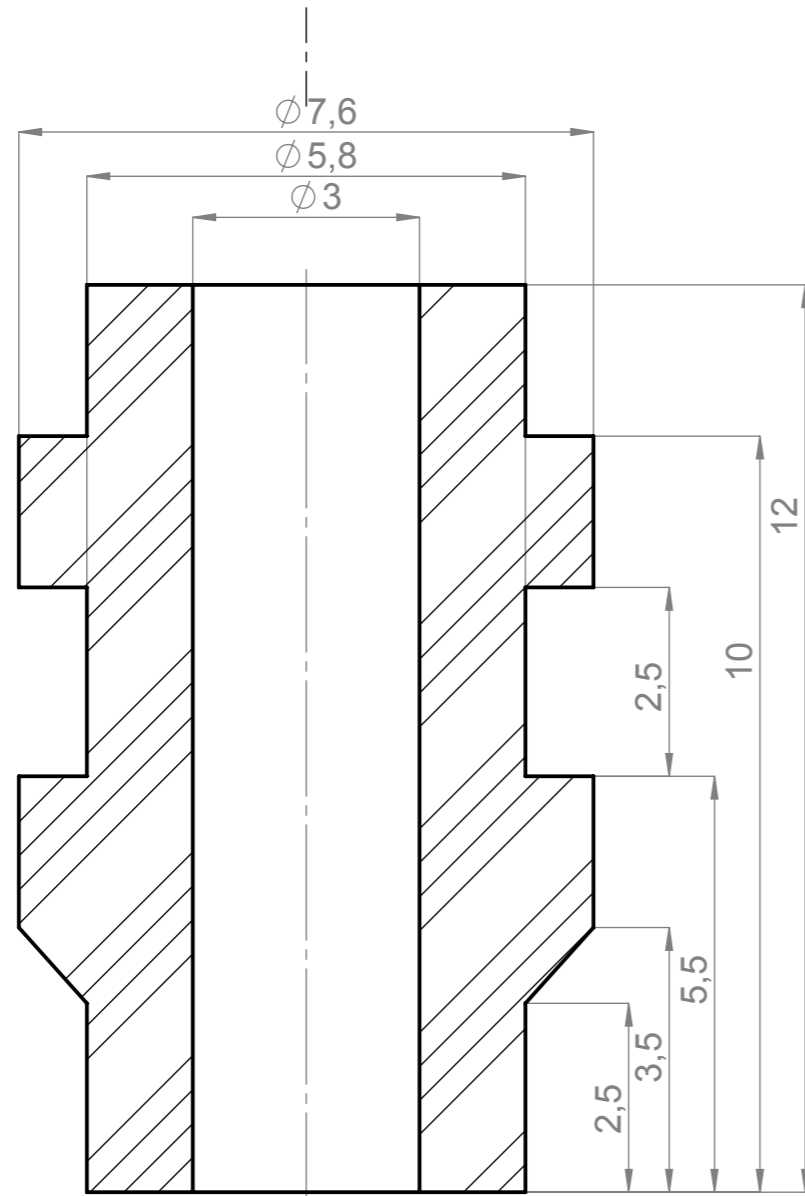

	Imię i nazwisko	Podpis	Data	Nazwa części	Objętość	Materiał
Konstruował:	P.D.			D199	317 [mm ³]	NBR
Sprawdził:						
Zatwierdził:						
Skala: 10:1				Cecha detalu Uszczelka		